

■全体図(単位mm) ($\frac{1}{200}$)

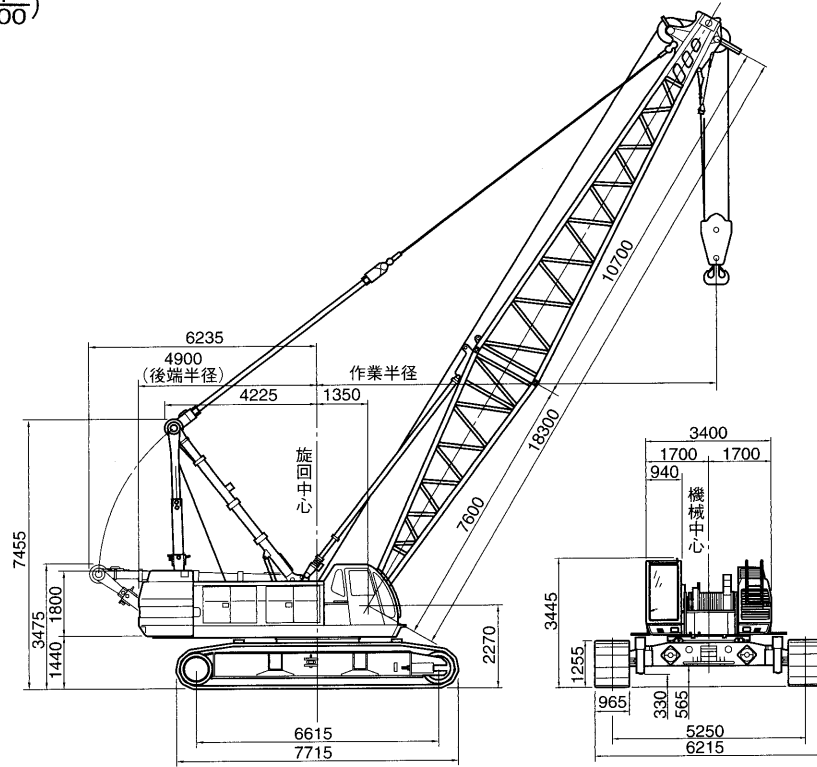

■作業範囲図

